

FACTOR 410 SIDE PANEL INSTALLATION MANUAL

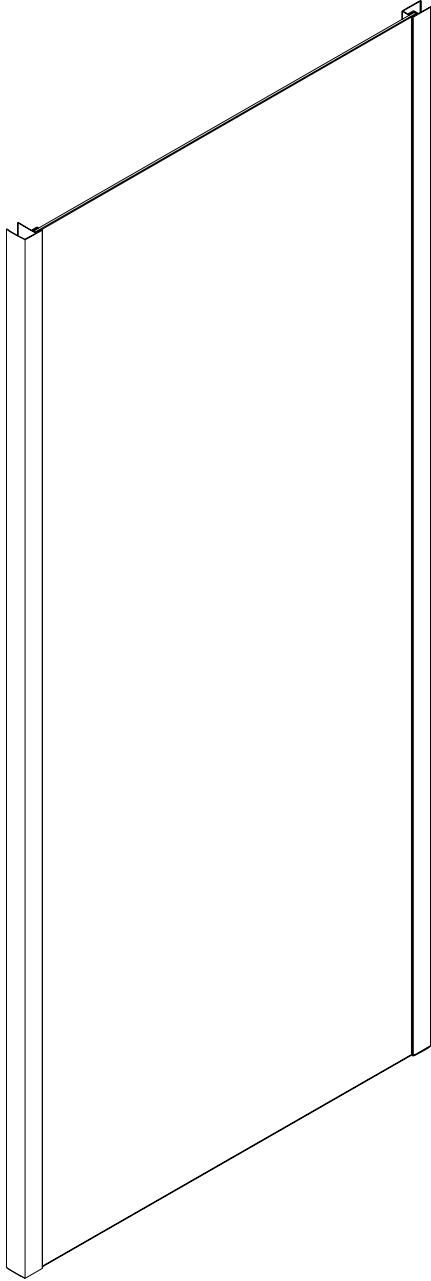

410.001

410.002

410.003

410.004

CE EN 14428

Assembly and installation guide

Before you start: ATTENTION

Please read these instructions through carefully before you start the installation. Incorrect product installation may result in serious product failure which will not be covered under your guarantee.







The wall profiles are designed to allow for 20mm adjustment when fitted to out of true walls. The thickness of the tiles used will affect the overall position of the assembly in situ.

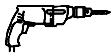

Check the number of components to ensure you have all the parts listed and make sure you have the right tools to hand.

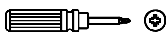
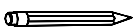
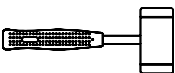
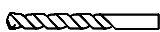
Two people are required for certain parts of the assembly and it is always recommended that a technically competent installer should undertake the installation.

Ensure that the enclosure is fitted to a level base. The wall plugs included with this product are suitable only for solid walls. Plasterboard or stud walls may require specialized fixings which are not provided. Handle all glass components with extreme care avoiding any damage to the corners and edges which may cause it to shatter.

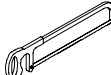
TOOLS REQUIRED

DESCRIPTION	PART IMAGE	DESCRIPTION	PART IMAGE
Tape measure		Drill	
Spirit level		Cross head screwdriver	
Pencil		Mallet	
Ø6mm Drill bit		Silicone sealant	
Ø3mm Drill bit		Gloves	
Protection eyeglasses		Hacksaw	

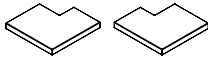
NO.	Item	Qty
1		x4
2	 ST4*10	x4
3		x2

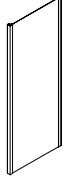
NO.	Item	Qty
4		x1

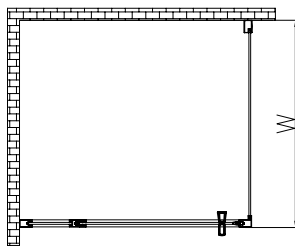
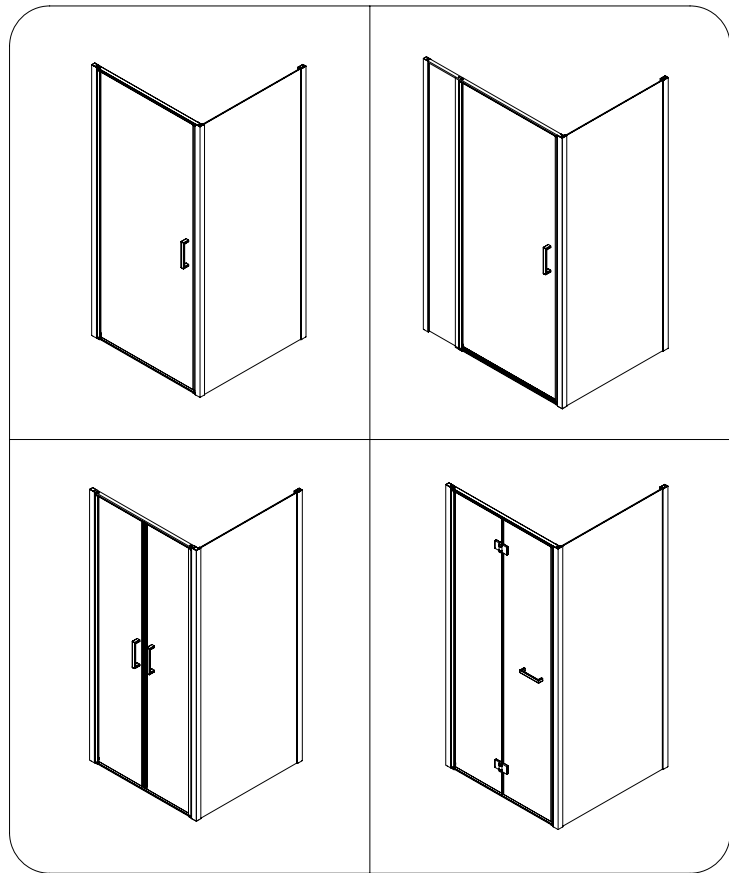
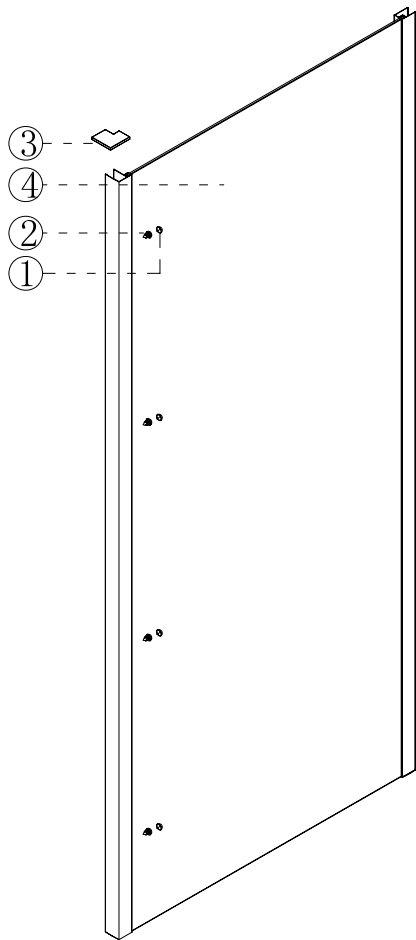

Profile Adjustments

Models	Min-Max
	W mm
700	670-690
800	770-790
900	870-890
1000	970-990

1. Install the wall jamb

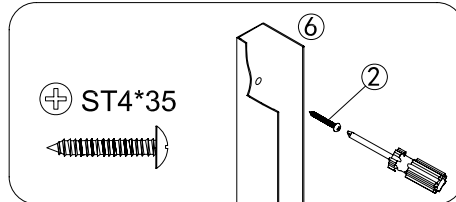
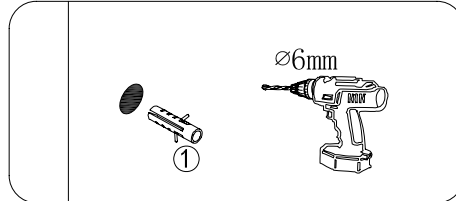
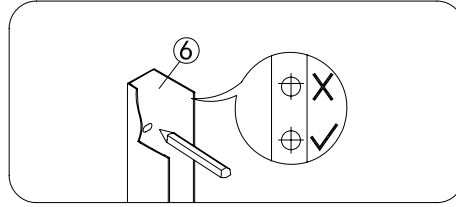
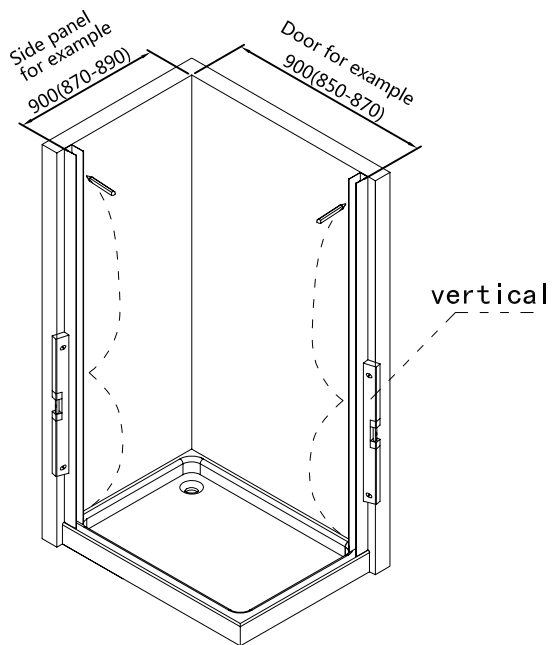

2. Assemble the side panel with the wall jamb

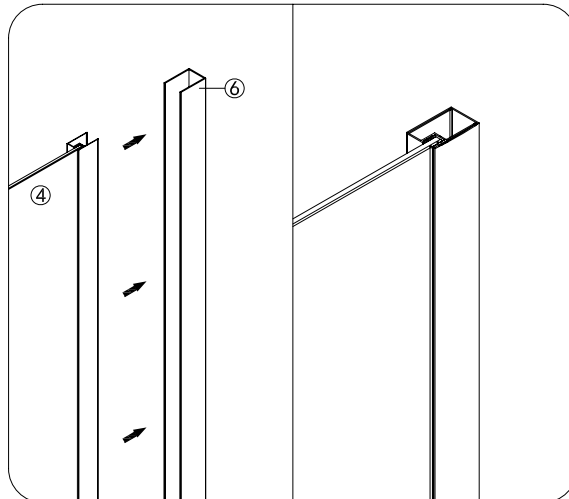
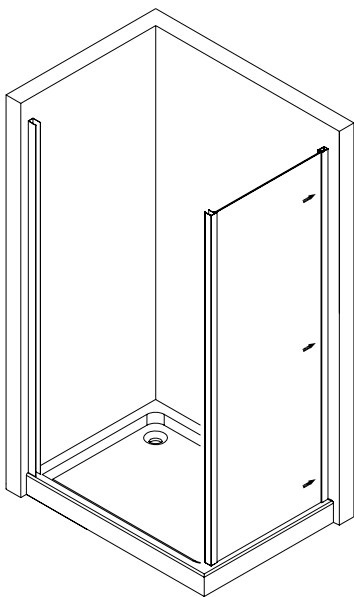

3. Install the front door according to the instruction

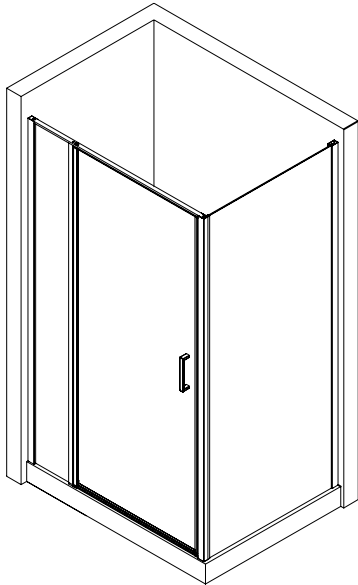

4. Move the door frame from left to right, ensure the door is closed and sealed, and fix the frame.

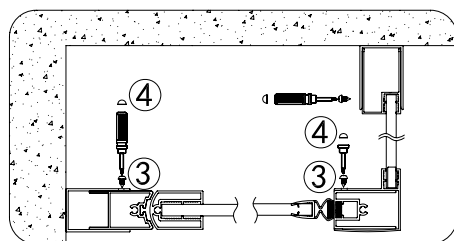
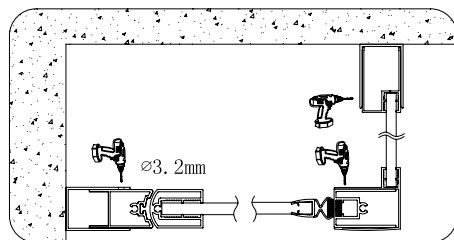
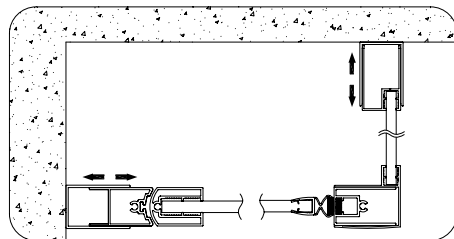
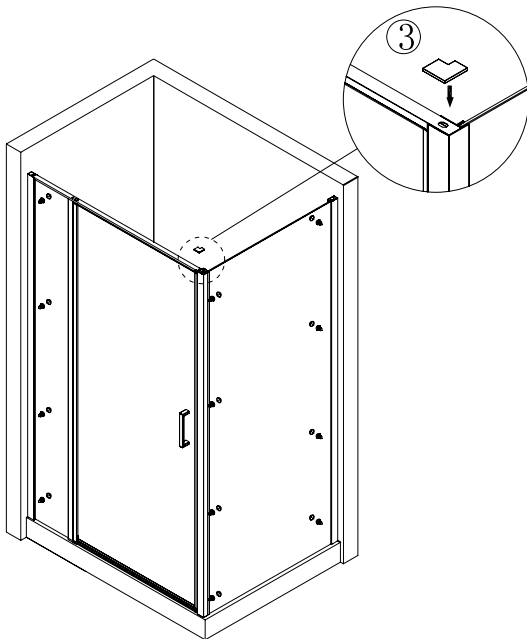

**5. Allow 24 hours for Silicone to dry before use
Silicone on the outside edge only as shown**

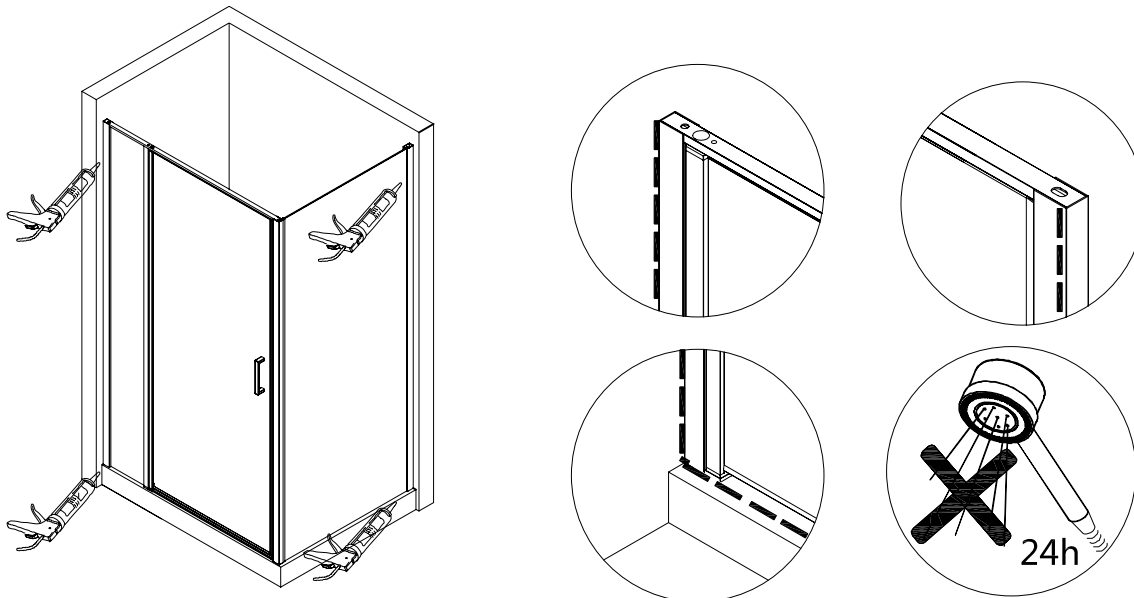

CARE AND MAINTANENCE :

It is important that you clean your shower enclosure after every use.

Soapy water is adequate to keep the glass clean however glass cleaner can be used if required. In hard water areas, insoluble lime scale may be deposited on the glass. If this is allowed to build up it becomes increasingly difficult to remove. Regular cleaning will minimise this effect.

NEVER use abrasive products or strong chemical cleaners on the glass.

Silicone spray may be used to lubricate rollers,hinges and other moving parts